

Varenummer: 204490ZD681SW
 Beskrivelse: E+G kuglelås
 GN 4490-ZD-68-1-SW

Mål

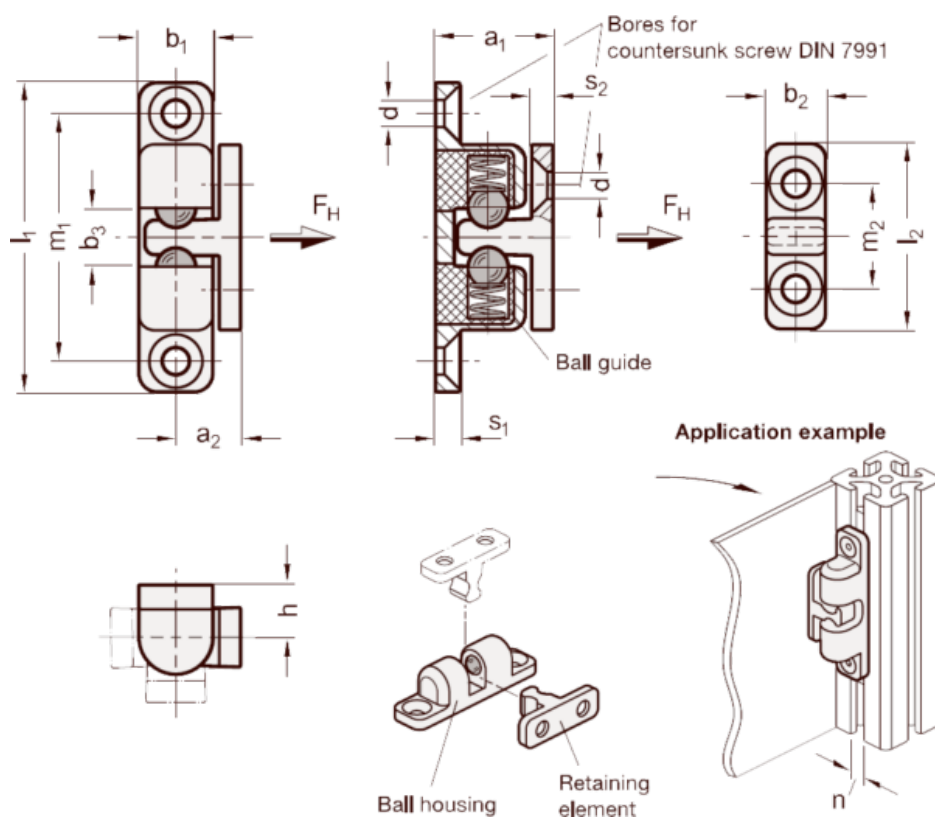

a1	= 23	Holdning force FH in N	= 50
a2	= 12	l1	= 68
b1	= 14.5	l2	= 32.5
b2	= 11	m1	= 55
b3	= 9.5	m2	= 20
d	= M 4	s1	= 5
for nut width n	= ? 8	s2	= 3.5
h	= 11	Vægt i (g)	= 55